



CROWN IMPERIAL ASSEMBLY INSTRUCTIONS

Base Diagonal Corner Unit



CROWN IMPERIAL ASSEMBLY INSTRUCTIONS

Base Diagonal Corner Unit

Base Diagonal Corner Parts

Parts Supplied



A



B



C

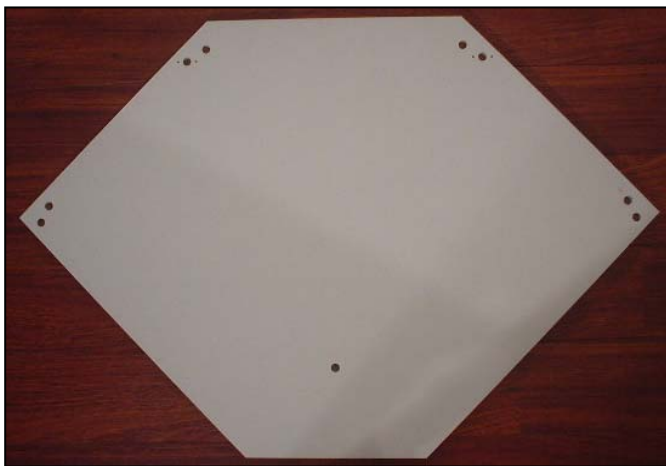

D



F



G



H



J



K

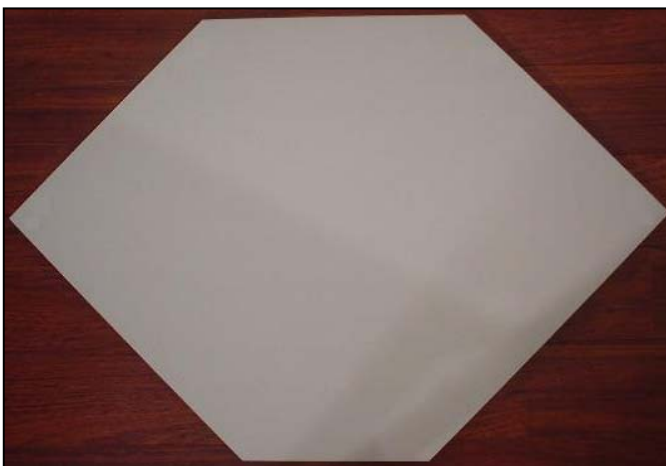

E



CROWN IMPERIAL ASSEMBLY INSTRUCTIONS

Base Diagonal Corner Unit

Part Letter	Part Name	Quantity
A	End Panel*	2
B	Thin Back Panel	2
C	Thick Back Panel	2
D	Top/Bottom Panel	2
E	Shelf	1
F	Spacer	4
G	45 Degree Clip Hinge	2
H	Hinge Plate	2
J	Feet Blocks	5
K	Adjustable Feet	5

** NOTE: End Panels are packed separately from all other parts supplied.*



CROWN IMPERIAL ASSEMBLY INSTRUCTIONS

Base Diagonal Corner Unit

A 	B 	C 	D 	E
F 	G 	H 	J 	K
L 	M 	N 	P 	Q
R 	S 	T 	U 	
V 	X 		Y 	
W 				



CROWN IMPERIAL ASSEMBLY INSTRUCTIONS

Base Diagonal Corner Unit

Fitting Letter	Fitting Name	Quantity
A	Metal Dowel	12
B	Metal Cam	12
C	Wooden Dowel 8 x 40mm	8
D	Wooden Dowel 5 x 25mm	
E	Connecting Screws (M/F)	3 pairs
F	Black Chipboard Screw 8 x 45mm	12
G	Countersunk Screw 8 x 1 ¼"	
H	Countersunk Screw 6 x 5/8"	10
J	Countersunk Screw 6 x ½"	4
K	Flange Head Screw 6 x ¾"	
L	Flange Head Screw 6 x 5/8"	12
M	Euro Screw 6 x 11mm	
N	Round Head Screw 6 x 5/8"	
P	Shelf Stud	4
Q	Rubber Sleeved Shelf Stud	
R	Angle Bracket	2
S	Door Buffer Pad	2
T	5mm Plugs	14
U	35mm Bung	
V	Crown Conceal Cap	
W	Hanging Plate	
X	Plinth Clip	2
Y	Peg-o-Lock	



CROWN IMPERIAL ASSEMBLY INSTRUCTIONS

Base Diagonal Corner Unit

Assembly Instructions

Step 1. Insert fittings into End Panels

Insert Metal Dowels (fitting A) and Wooden Dowels (fitting C) into the end panel, as shown.

Mirror this for the remaining end panel.

1.1. Insert fittings A and C

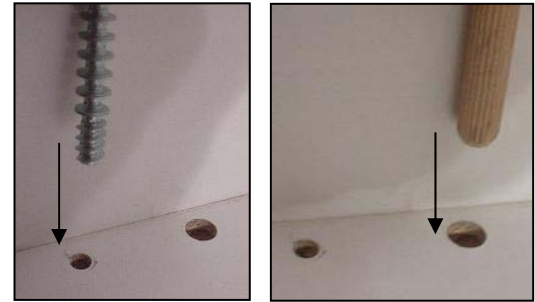

1.2. Positions of fittings A and C on End Panels

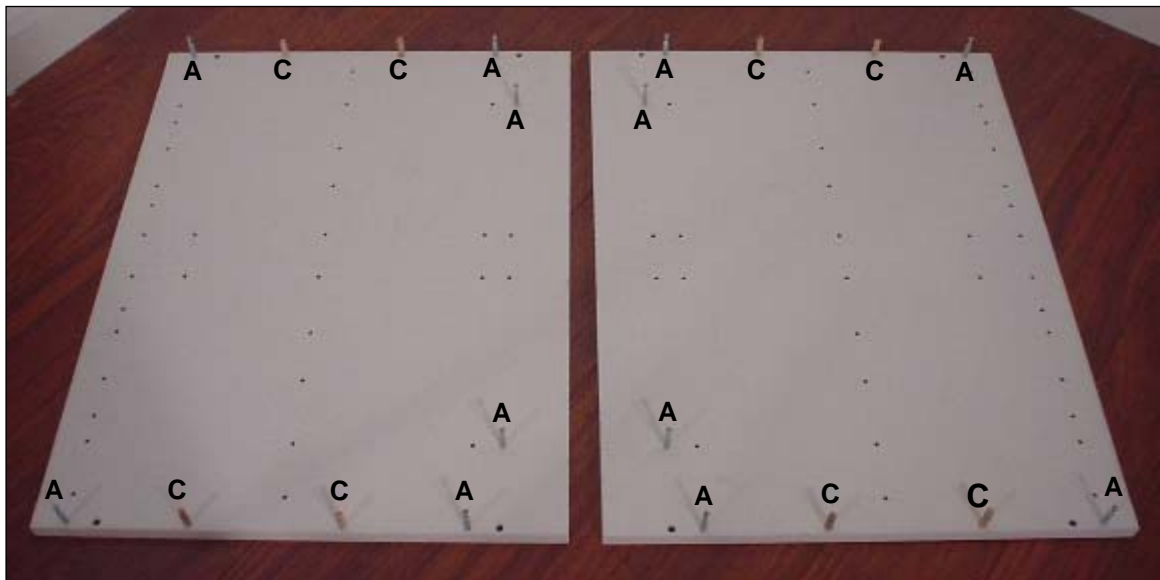



CROWN IMPERIAL ASSEMBLY INSTRUCTIONS

Base Diagonal Corner Unit

Step 2. Top/Bottom Panel

Insert the Circular Cams (fitting B) into the holes in the top panel.

Ensure the arrows on the circular cams, are pointing outwards, towards the pre-drilled edge.

Repeat for the bottom panel.

2.1. Insert fitting B

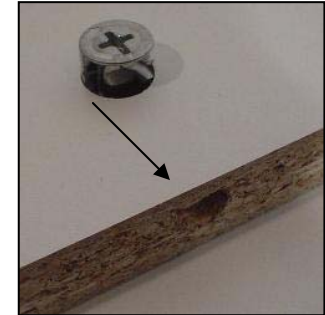

2.2. Fitting B in Top/Bottom Panel

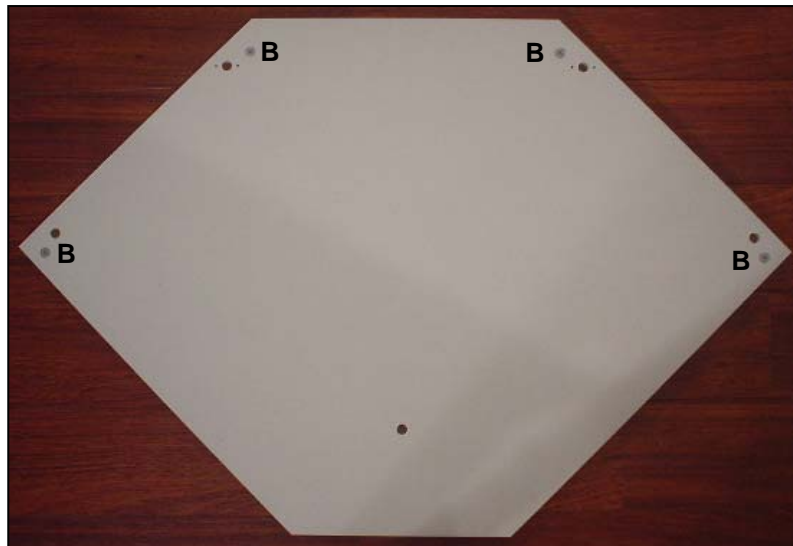



CROWN IMPERIAL ASSEMBLY INSTRUCTIONS

Base Diagonal Corner Unit

Step 3. Fit Top and Bottom Panels

Step 3.1

Take the top panel and push firmly home onto the end panel, as shown.

Ensure the cams are facing outwards.

3.1. Fit Top Panel to End Panel



Step 3.2

Using a screwdriver, turn the circular cam clockwise to lock.

Repeat for all cams.

3.2. Lock Cams to secure

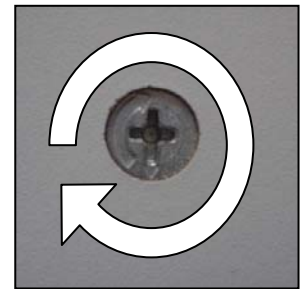

Step 3.3

Repeat the above, to fix the bottom panel.

3.3. Repeat to attach Bottom Panel





CROWN IMPERIAL ASSEMBLY INSTRUCTIONS

Base Diagonal Corner Unit

Step 4. Fit remaining End Panel

Fit the remaining End Panel.

Lock the cams, as before.

4. Fit remaining End Panel



Step 5. Thick Back Panels

Step 5.1.

Insert Circular Cams (fitting B) into the two thick Back Panels.

5.1. Fitting B in thick Back Panel

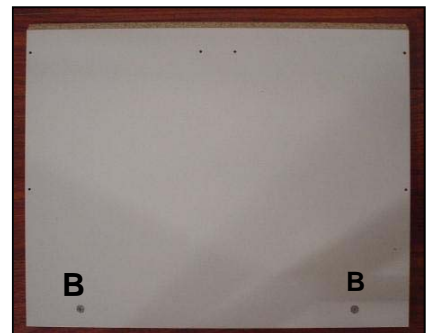

Step 5.2

Take the first thick back panel and slide it onto the metal dowels, as shown.

Lock all cams.

Secure the back panel, using four screws (fitting F), per panel, positioned as shown.

5.2. Secure thick Back Panel

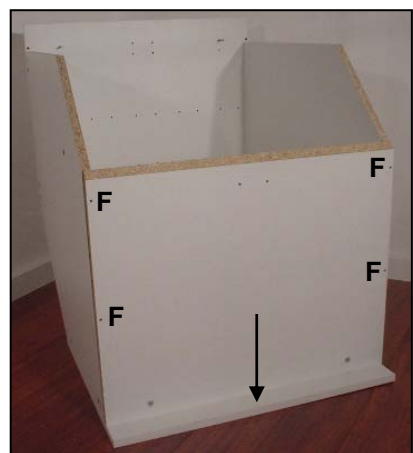



CROWN IMPERIAL ASSEMBLY INSTRUCTIONS

Base Diagonal Corner Unit

Step 6. Insert Shelving

NOTE: If you require a shelf in the cabinet, slide it in now, as it WILL NOT be possible to install it later.

6.1. Insert Loose Shelf NOW, if required

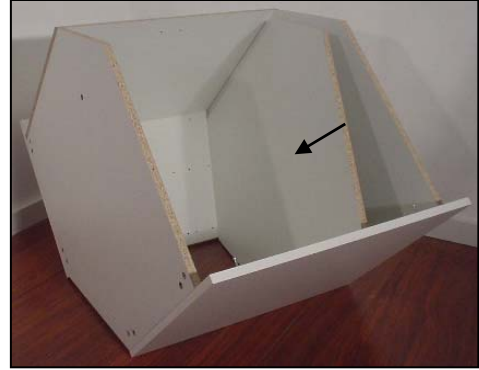

Step 7. Fit remaining thick Back Panel

Fit the remaining thick back panel, exactly as before, in Step 5.

7.1. Fit remaining thick Back Panel

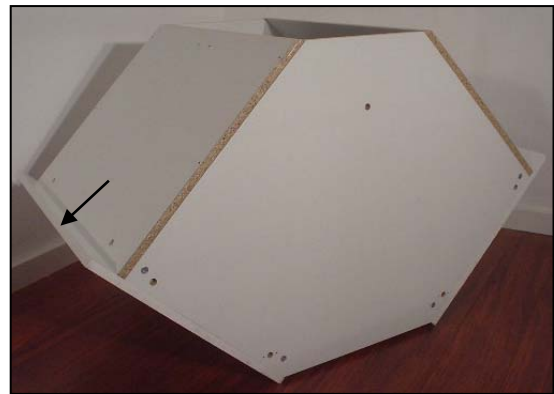

Step 8. Thin Back Panel

Position the thin back panel on the top and bottom, as shown.

Ensure the face matching the colour of the cabinet, is facing inwards.

Secure the thin back panel to the top, bottom and two thicker side panels, using twelve screws (fitting L) as shown.

8. Secure thin Back Panel to Cabinet

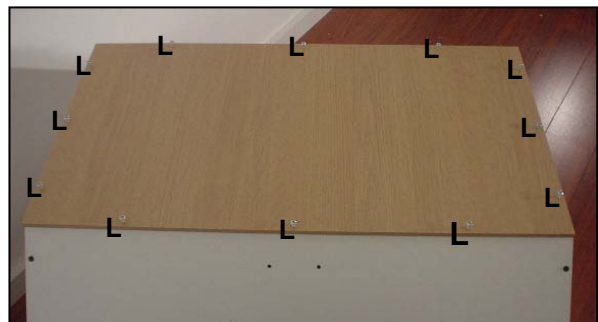



CROWN IMPERIAL ASSEMBLY INSTRUCTIONS

Base Diagonal Corner Unit

Step 9. Fitting Feet

Step 9.1 Attaching the Foot Blocks

On the bottom panel of the cabinet, locate the foot blocks with the flange facing the edge of the cabinet and push home.

9.1 Fix in Foot Blocks

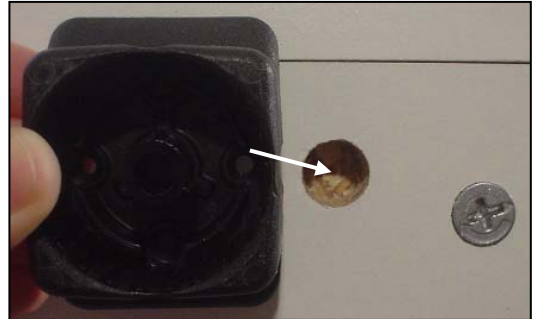

Step 9.2 Securing Foot Blocks

To secure the foot blocks, hit the spigots 'X' with a hammer, as shown, taking care not to damage the surround.

Using two countersunk screws (fitting H), per block, secure further.

9.2 Secure Feet Blocks



Step 9.3 Push Feet into Foot Blocks

Push the adjustable feet, into the foot blocks. Adjust the height of the feet by turning them.

There is a sequence of numbers written on the feet to aid adjusting all feet to the same height.

Repeat for all five feet.

9.3 Fit Feet and Adjust Height





CROWN IMPERIAL ASSEMBLY INSTRUCTIONS

Base Diagonal Corner Unit

Step 10. Fitting the Unit

When fitting the unit in position, use the spacers provided to achieve a 12mm forward offset, as shown.

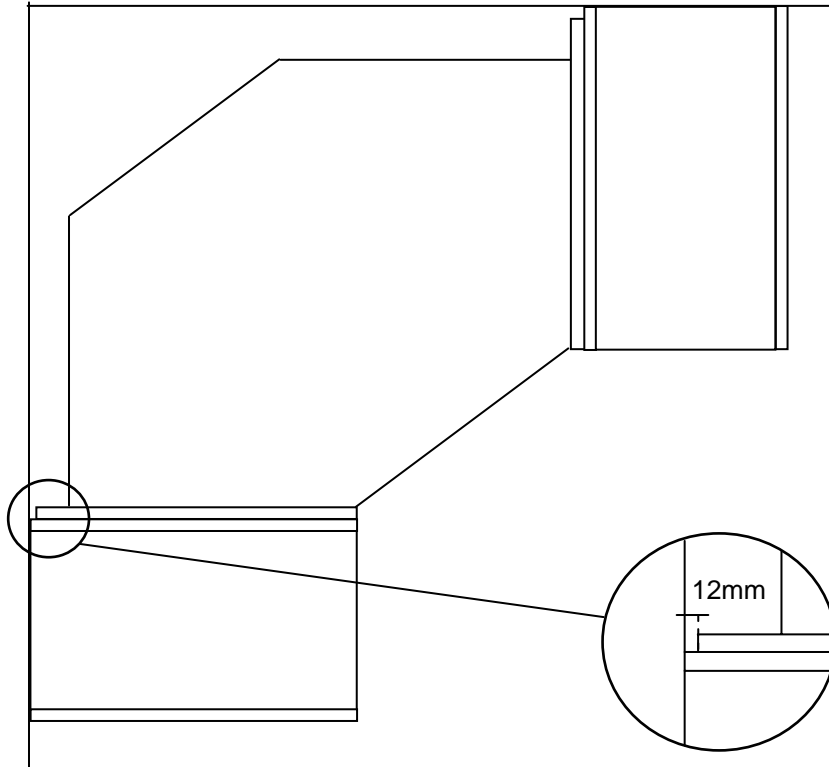

Step 11. Shelving

NOTE: Shelving is optional.

When the cabinet is installed, raise shelf accordingly to the height desired.



CROWN IMPERIAL ASSEMBLY INSTRUCTIONS

Base Diagonal Corner Unit

Complete Base Diagonal Corner Unit

